

## IEG1-1REG4-26371-6-V

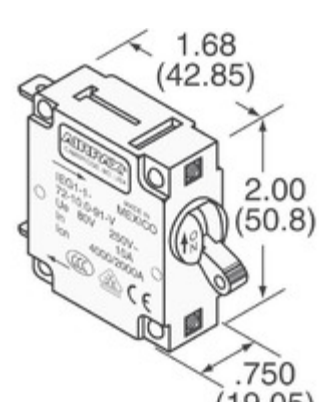

Obrázky jsou pouze orientační.  
Podrobné informace o produktu naleznete v části Technické údaje produktu.  
**Koupit IEG1-1REG4-26371-6-V s důvěrou od Component-World.HK, 1 rok záruka**



**Part Number:** [IEG1-1REG4-26371-6-V](#)  
**Výrobce:** [Sensata Technologies, Airpax](#)  
**Popis:** CIR BRKR MAG-HYDR LEVER  
**Datový list:** [IEG, IUG, JEG, CEG, LEG Series Datasheet](#)

**RoHS Status:** Bez olova / V souladu RoHS  
**Ship From:** Hong Kong  
**Shipment Way:** DHL/Fedex/TNT/UPS/EMS

[Request For Quotation](#)







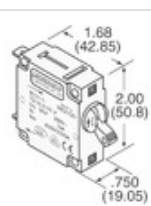
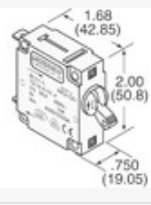
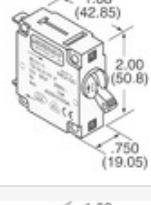

### PARAMETR PRODUKTU

<b>Part Number</b>	IEG1-1REG4-26371-6-V	<b>Výrobce</b>	<a href="#">Sensata Technologies, Airpax</a>
<b>Popis</b>	CIR BRKR MAG-HYDR LEVER	<b>Stav volného vedení / RoHS</b>	Bez olova / V souladu RoHS
<b>Dostupné množství</b>	1970 pcs	<b>Datový list</b>	<a href="#">IAG,IUG,JEG,CEG,LEG Series Datasheet</a>
<b>Kategorie</b>	<a href="#">Ochrana obvodu</a>	<b>Série</b>	IEG
<b>Počet pólů</b>	1	<b>Typ montáže</b>	Panel Mount
<b>Úroveň citlivosti na vlhkost (MSL)</b>	1 (Unlimited)	<b>Výrobní standardní doba výroby</b>	6 Weeks
<b>Stav volného vedení / RoHS</b>	Lead free / RoHS Compliant	<b>Osvětlení napětí (nominální)</b>	-
<b>Osvětlení</b>	-	<b>Jmenovitá hodnota proudu</b>	-
<b>Breaker Typ</b>	Magnetic (Hydraulic Delay)	<b>Pohon Type</b>	Lever

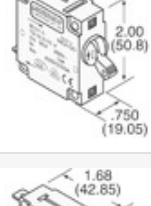
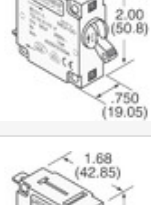
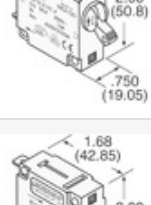
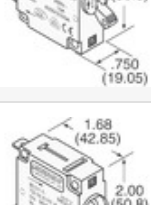
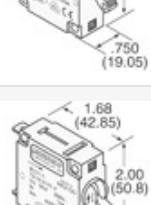
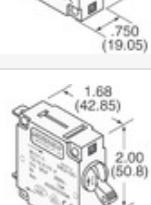
Component-World.com je spolehlivý distributor elektronických součástek. Specializujeme se na všechny elektronické komponenty řady Sensata Technologies, Airpax. Máme 1970 kusy Sensata Technologies, Airpax IEG1-1REG4-26371-6-V na skladě dostupných. Vyžádejte si citát z distributora součástí elektroniky na Component-World.com, náš prodejní tým vás bude kontaktovat do 24 hodin.

RFQ Email: [info@Components-World.com](mailto:info@Components-World.com)

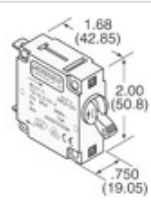
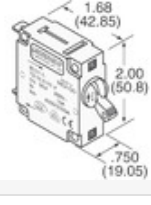
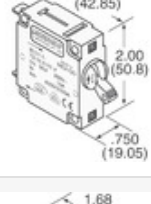
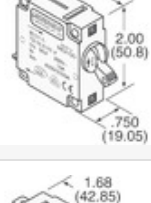
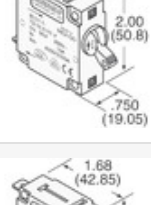
### SOUVISEJÍCÍ PRODUKTY

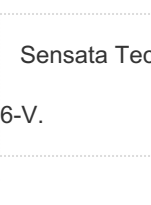
	<b>Část#: <a href="#">IEG1-1REC5-61-100-21-V</a></b> <b>Popis:</b> CIR BRKR MAG-HYDR LEVER .1A	<b>Výrobci:</b> <a href="#">Sensata Technologies, Airpax</a>	<a href="#">Dotaz</a>
	<b>Část#: <a href="#">IEG1-1REC5-69-500-31-UV</a></b> <b>Popis:</b> CIR BRKR MAG-HYDR 500MA LEVER	<b>Výrobci:</b> <a href="#">Sensata Technologies, Airpax</a>	<a href="#">Dotaz</a>
	<b>Část#: <a href="#">IEG1-1REG4-51-10.0-A-01-V</a></b> <b>Popis:</b> CIR BRKR MAG-HYDR	<b>Výrobci:</b> <a href="#">Sensata Technologies, Airpax</a>	<a href="#">Dotaz</a>
	<b>Část#: <a href="#">IEG1-1REG4-35887-15-V</a></b> <b>Popis:</b> CIR BRKR MAG-HYDR LEVER	<b>Výrobci:</b> <a href="#">Sensata Technologies, Airpax</a>	<a href="#">Dotaz</a>
	<b>Část#: <a href="#">IEG1-1REC5-61-15.0-11-V</a></b> <b>Popis:</b> CIR BRKR MAG-HYDR	<b>Výrobci:</b> <a href="#">Sensata Technologies, Airpax</a>	<a href="#">Dotaz</a>
	<b>Část#: <a href="#">IEG1-26078-1-V</a></b> <b>Popis:</b> CIR BRKR MAG-HYDR LEVER	<b>Výrobci:</b> <a href="#">Sensata Technologies, Airpax</a>	<a href="#">Dotaz</a>
	<b>Část#: <a href="#">IEG1-1REG4-51-20.0-A-01-V</a></b> <b>Popis:</b> CIR BRKR MAG-HYDR	<b>Výrobci:</b> <a href="#">Sensata Technologies, Airpax</a>	<a href="#">Dotaz</a>
	<b>Část#: <a href="#">IEG1-1REC4-72-15.0-91-V</a></b> <b>Popis:</b> CIR BRKR MAG-HYDR	<b>Výrobci:</b> <a href="#">Sensata Technologies, Airpax</a>	<a href="#">Dotaz</a>
	<b>Část#: <a href="#">IEG1-1REC5-69-500-31-V</a></b> <b>Popis:</b> CIR BRKR MAG-HYDR	<b>Výrobci:</b> <a href="#">Sensata Technologies, Airpax</a>	<a href="#">Dotaz</a>
	<b>Část#: <a href="#">IEG1-26078-5-V</a></b> <b>Popis:</b> CIR BRKR MAG-HYDR LEVER	<b>Výrobci:</b> <a href="#">Sensata Technologies, Airpax</a>	<a href="#">Dotaz</a>
	<b>Část#: <a href="#">IEG1-1REC5-62-250-91-C</a></b> <b>Popis:</b> CIR BRKR MAG-HYDR LEVER .25A	<b>Výrobci:</b> <a href="#">Sensata Technologies, Airpax</a>	<a href="#">Dotaz</a>
	<b>Část#: <a href="#">IEG1-1REC5-51F-8.00-A-01-V</a></b> <b>Popis:</b> CIR BRKR MAG-HYDR	<b>Výrobci:</b> <a href="#">Sensata Technologies, Airpax</a>	<a href="#">Dotaz</a>
	<b>Část#: <a href="#">IEG1-29230-2-V</a></b> <b>Popis:</b> CIR BRKR MAG-HYDR LEVER	<b>Výrobci:</b> <a href="#">Sensata Technologies, Airpax</a>	<a href="#">Dotaz</a>
	<b>Část#: <a href="#">IEG1-1REC5-69-1.00-31-V</a></b> <b>Popis:</b> CIR BRKR MAG-HYDR	<b>Výrobci:</b> <a href="#">Sensata Technologies, Airpax</a>	<a href="#">Dotaz</a>
	<b>Část#: <a href="#">IEG1-29230-1-V</a></b> <b>Popis:</b> CIR BRKR MAG-HYDR LEVER	<b>Výrobci:</b> <a href="#">Sensata Technologies, Airpax</a>	<a href="#">Dotaz</a>
	<b>Část#: <a href="#">IEG1-21478-2</a></b> <b>Popis:</b> CIR BRKR MAG-HYDR LEVER	<b>Výrobci:</b> <a href="#">Sensata Technologies, Airpax</a>	<a href="#">Dotaz</a>
	<b>Část#: <a href="#">IEG1-1REG4-51-2.00-A-01-V</a></b> <b>Popis:</b> CIR BRKR MAG-HYDR	<b>Výrobci:</b> <a href="#">Sensata Technologies, Airpax</a>	<a href="#">Dotaz</a>
	<b>Část#: <a href="#">IEG1-1REC5-69-100-21-V</a></b> <b>Popis:</b> CIR BRKR MAG-HYDR	<b>Výrobci:</b> <a href="#">Sensata Technologies, Airpax</a>	<a href="#">Dotaz</a>
	<b>Část#: <a href="#">IEG1-25715-1</a></b> <b>Popis:</b> CIR BRKR MAG-HYDR LEVER	<b>Výrobci:</b> <a href="#">Sensata Technologies, Airpax</a>	<a href="#">Dotaz</a>
	<b>Část#: <a href="#">IEG1-1REC5-62-250-91-V</a></b> <b>Popis:</b> CIR BRKR MAG-HYDR	<b>Výrobci:</b> <a href="#">Sensata Technologies, Airpax</a>	<a href="#">Dotaz</a>

### Související klíčová slova pro IEG1-1REG4-26371-6-V

Sensata Technologies, Airpax IEG1-1REG4-26371-6-V.	IEG1-1REG4-26371-6-V distributor	IEG1-1REG4-26371-6-V dodavatel	IEG1-1REG4-26371-6-V Cena
koupit IEG1-1REG4-26371-6-V.	IEG1-1REG4-26371-6-V Stáhnout datasheet.	IEG1-1REG4-26371-6-V Datasheet.	IEG1-1REG4-26371-6-V Stock.
	Sensata Technologies, Airpax IEG1-1REG4-26371-6-V.	Sensata Technologies/Airpax IEG1-1REG4-26371-6-V.	